



INSPIRE   
**AWARDS**

# THE FOURTH ANNUAL GLOBAL STUDENT CONTEST

— 1.10 2018 - 1.10 2019

[www.inspireliawards.com](http://www.inspireliawards.com)

For four years, we have been helping to make young talents to be recognized, join us.

Join a project that can appeal to the whole generation of young architects. Be at their start and help them find a way to realize their professionalism.

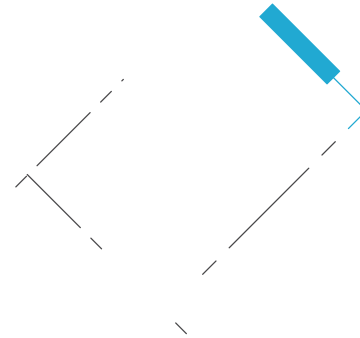

INSPIRELI AWARDS Ceremony at the Czech Technical University in Prague.

## ABOUT INSPIRELI AWARDS

The original idea of the competition came from President Vaclav Havel and Professor Bořek Šípek. The aim was to build a platform helping up-and-coming talents in architecture, regardless of their economic, social or ethnic conditions.

Within three years of the INSPIRELI AWARDS project launch, the idea has developed into one of the World's largest student competitions.

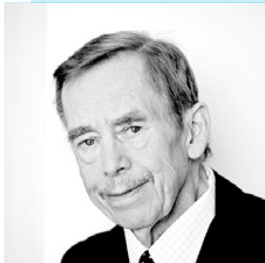

Václav Havel

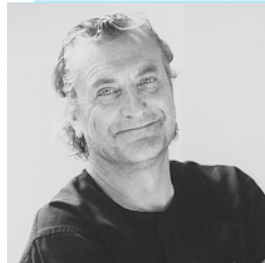

Bořek Šípek

### 1st annual INSPIRELI AWARDS

25+ countries, 250+ competitors, 1 category

### 2nd annual INSPIRELI AWARDS

99+ countries, 1000+ contestants, 1 category

### 3rd annual INSPIRELI AWARDS

100+ countries, 700+ contestants, 2 categories

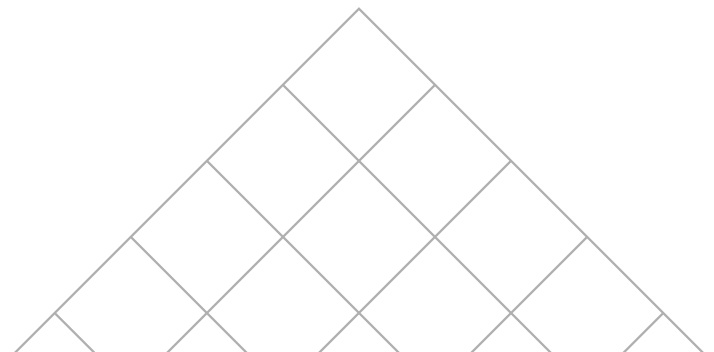

## AWARD ORGANIZERS

The award began in 2014 as a private initiative of several friends, who at its first year in 2015 received the worldwide support of the Czech Ministry of Education. From 2017, the Czech Technical University in Prague has been actively involved in the competition, which is already a direct member of the realization team.

Voting systems are developed in cooperation with the Karel Janeček's D21 Company.

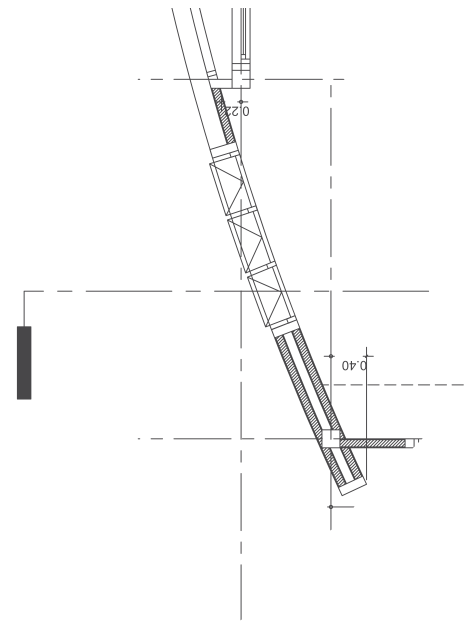
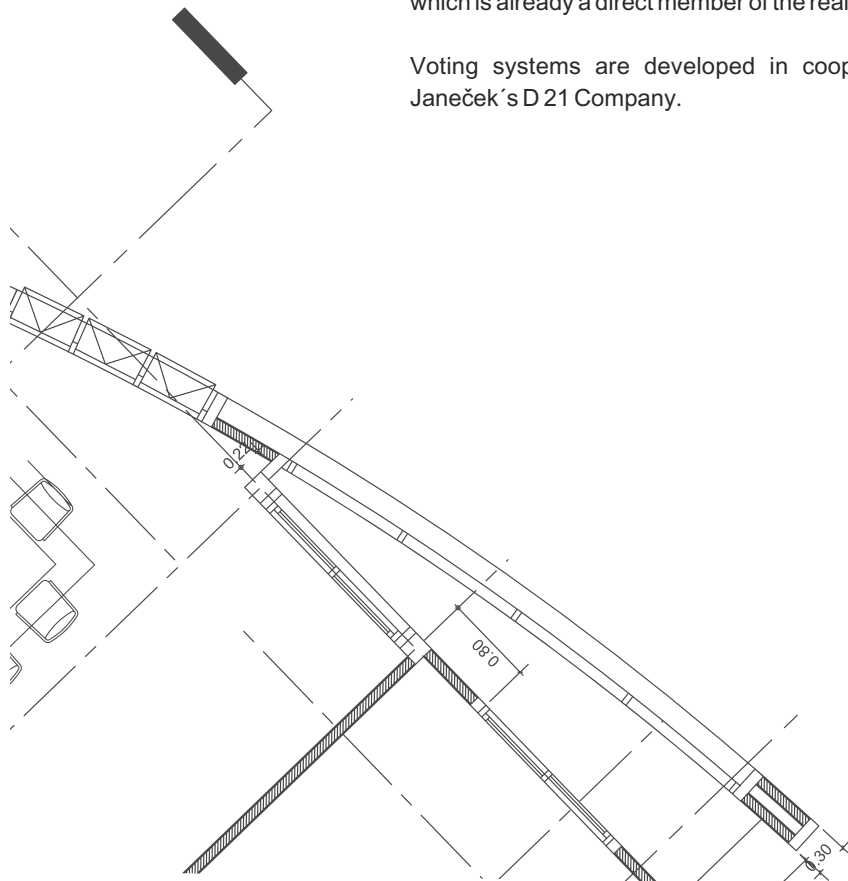

INSPIRE   
AWARDS

Main media partner:



## OUR SUPPORT OF YOUNG TALENTS

We helped to recognize 2 000+ young talents from more than 120 countries whom the world would never know.

We show young talents from over 20 African countries and change minds on this continent.

We connect young students with the most famous architects in the World.

Hundreds of universities, dozens of associations and hundreds of thousands of world architects know that the Czech Republic has a competition supporting young talents and is known by CTU and its 300-year tradition.

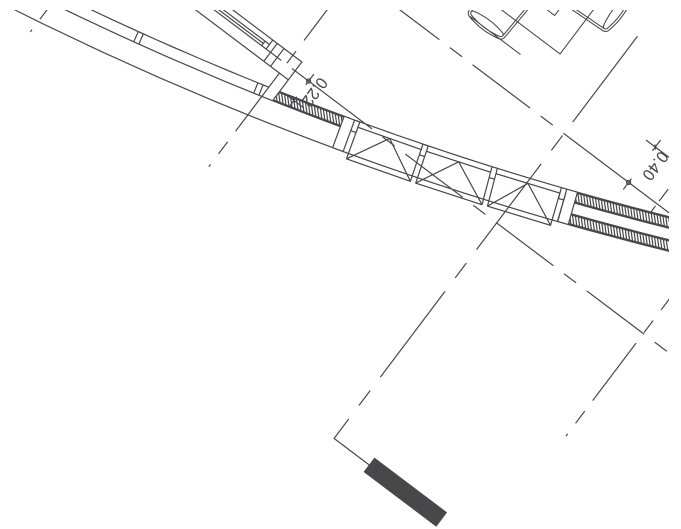

Thanks to us the Winner of INSPIRELI AWARDS 2015 Yaojian Guo traveled from China for the first time.



The award is always free, so student Adnan Aboras from Jemen competed in INSPIRELI AWARDS, even though there was a military conflict around him.





## OUR SUPPORT OF YOUNG TALENTS



Somayeh Ravanshad, Professor of the University of Architecture in Iran, who last year was the best ambassador for Inspireli is selected as a young jury of competition.



Student Martin Hořešovský met the most prominent architect of Indonesia Budi Pradono and became a member of his team during the Venice Biennale.



Ksenia Zabardygina a winner of the vision category from Siberia (Russia), obtained a flight ticket to Prague for a grand ceremony where her international visibility took place.

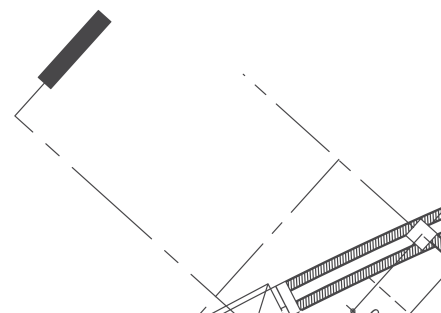

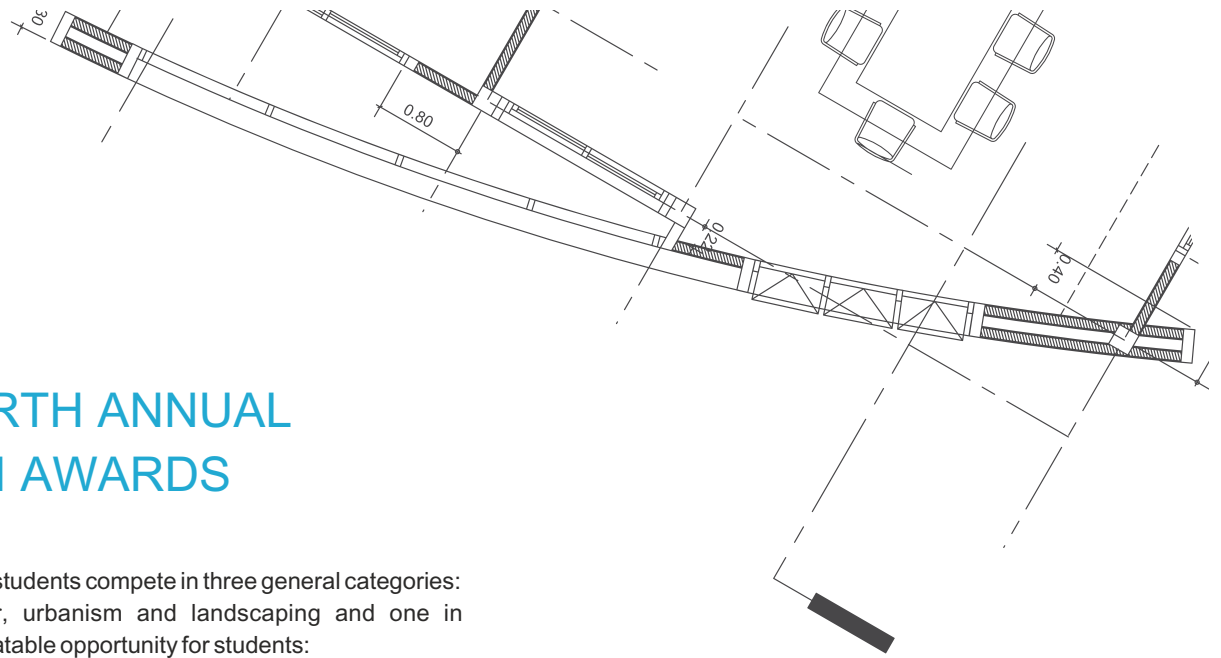

## THE FOURTH ANNUAL INSPIRELI AWARDS

In the fourth year the students compete in three general categories: architecture, interior, urbanism and landscaping and one in particular, an unrepeatable opportunity for students:

a study of the Embassy of the Czech Republic in Addis Ababa, Ethiopia, for the Ministry of Foreign Affairs of the Czech Republic. The author's name will be written on the wall of the Embassy.

The INSPIRELI AWARDS competition covers the entire academic year.

May 2018

Start of pre-registration

01 October 2018

Start of signing up for the competition

June 12, 2019

Termination of registration for the competition

June 13, 2019

Start of voting in the semifinals

01 July 2019

Announcement of finalists in three categories

01 October 2019

Announcement of the winners

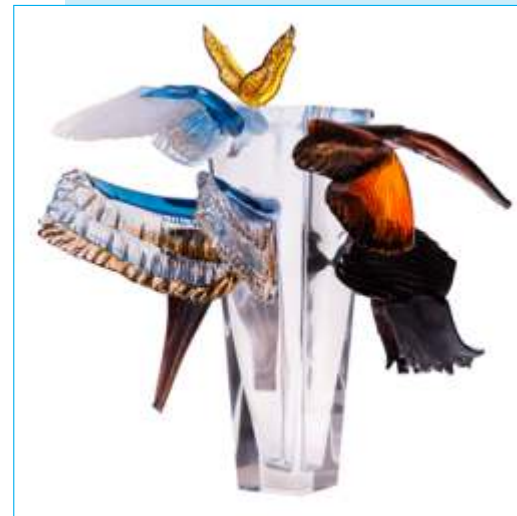

The vase „WINGS TO THE FUTURE“.

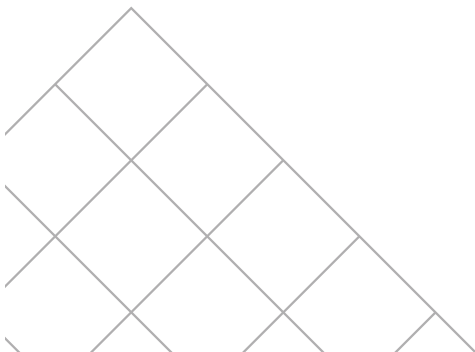

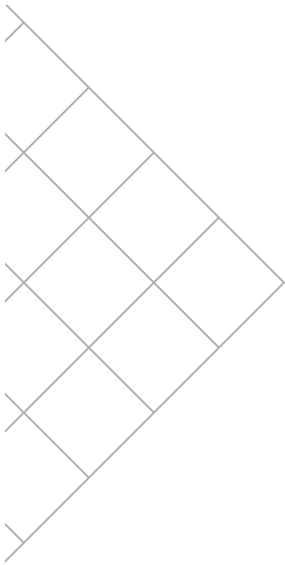

## THIS ANNUAL IS EXTRAORDINARY!

---

Through INSPIRELI AWARDS, students from all over the world have a unique opportunity to participate in the project of the new Embassy of the Czech Republic in Addis Ababa, Ethiopia, which will be realized on the basis of the winning Idea Design.

The aim of INSPIRELI AWARDS is, from the very beginning, to involve students in real-life projects, where they can then further develop their professional careers. The project of the Embassy in Ethiopia is the most prestigious form of how we can start these activities.

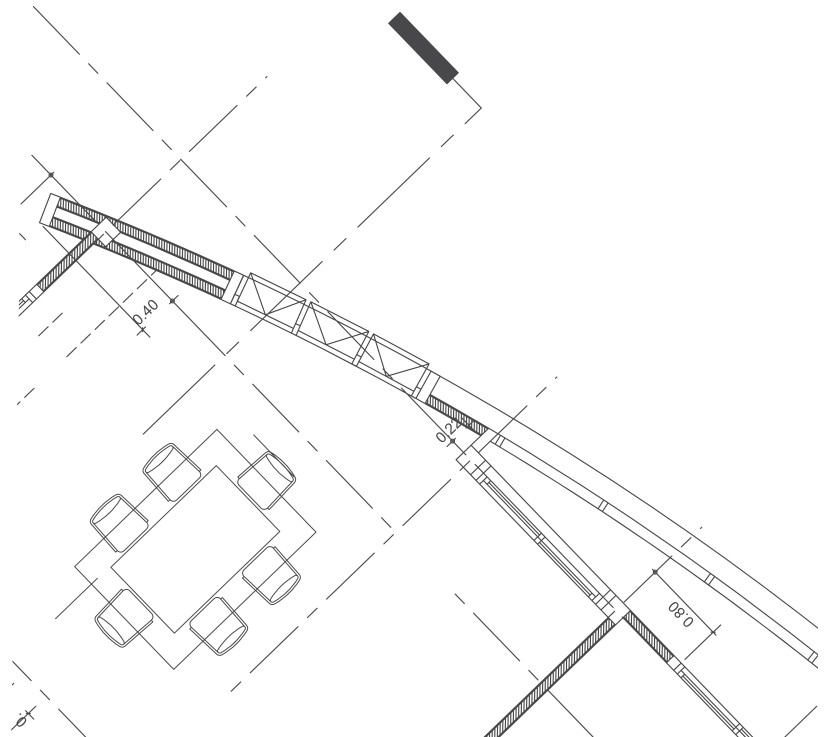



# REALIZATION TEAM

The foundation of the stability of the whole is in the variety of its parts.

The INSPIRELI AWARDS realization team was set up in 2014 and a number of top experts have contributed to the project. Currently the team consist of two founders Karel Smejkal and Kamil Šimkovič and two leading experts in their fields Otto Dvorak and Karel Janeček.

**Karel Smejkal** is Vice-chairman of the Czech Society of Architects, a member of the American Institute of Architects and he is involved in the research of psychology of architecture at the Czech Technical University in Prague.

**Kamil Šimkovič** as an economist ensuring the accounting and financial aspects of the project.

**Otto Dvorak**, a member of the American Institute of Architects, has been a longtime professor at Harvard University and is currently one of the world's expert in architecture, urban planning and conservation. Its services are used by leading home and world developers.

Successful entrepreneur and philanthropist **Karel Janeček** is the newest member of the core realization team, which provides software support and technology for evaluating modules within the project.

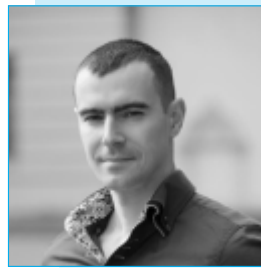
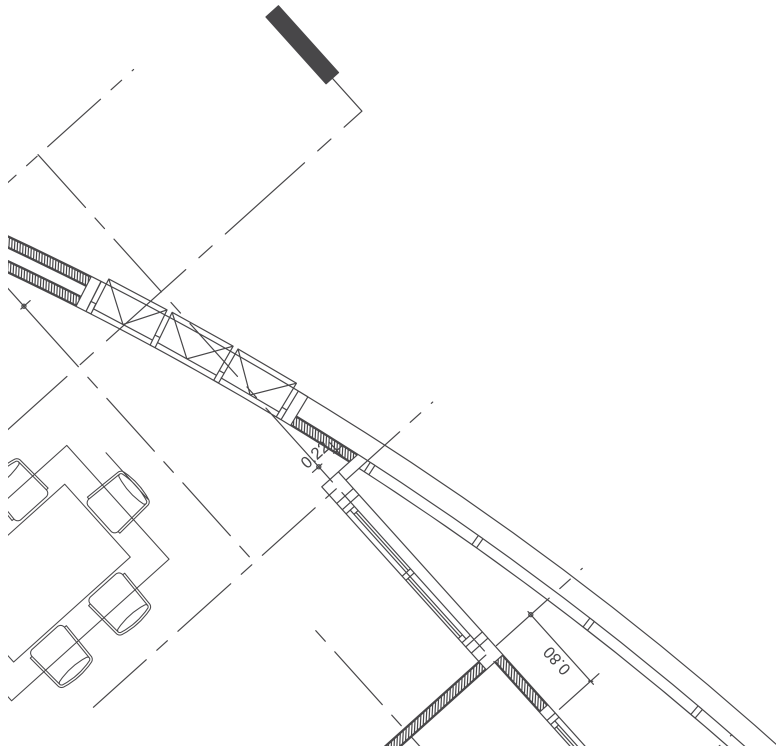

Karel Smejkal



Otto Dvorak



Kamil Šimkovič



Karel Janeček

# 3rd Annual Winner WINGS TO THE FUTURE GRAND PRIZE JURY AWARD

Francesca Vittorini, Andrea Tabocchini  
Italy

Reconstruction of a family house

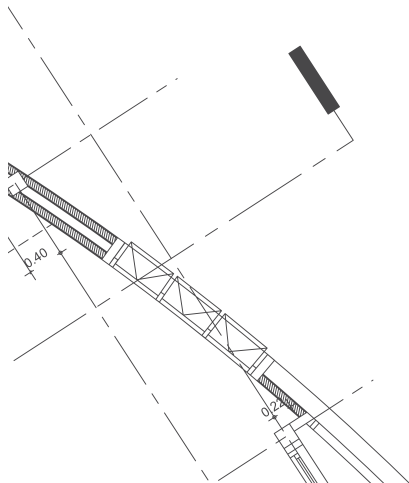
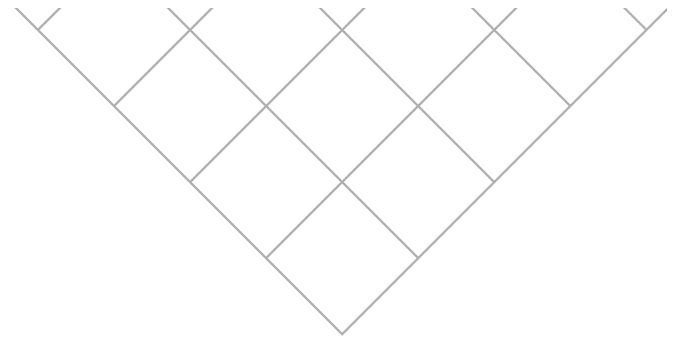

## INSIDEOUT SCHOOL IN GHANA

As its name suggests, the “Inside Out School” blurs the boundaries between inside and outside, offering an alternative to standard introverted classrooms and proposing an affordable and easily replicable design that values local know-how. The authors of this project intended it to be recognized not only for its architectural quality but particularly for its innovative and experimental approach. The school is built by hand from materials available on the site (earth, wood and vegetation). The lack of resources and the site limitations inspired the architects to take on a sustainable design strategy that merges architecture and landscape. The staggered walls of the classrooms are built by compacting local earth. A wood structure supports the roof, allowing light into the building, and permitting natural ventilation. The porch extends into the garden expanding the shaded area outdoors. Using social media the authors inspired others to contribute their time, effort and money resulting in the actual construction of this project at a primitive site in Ghana.

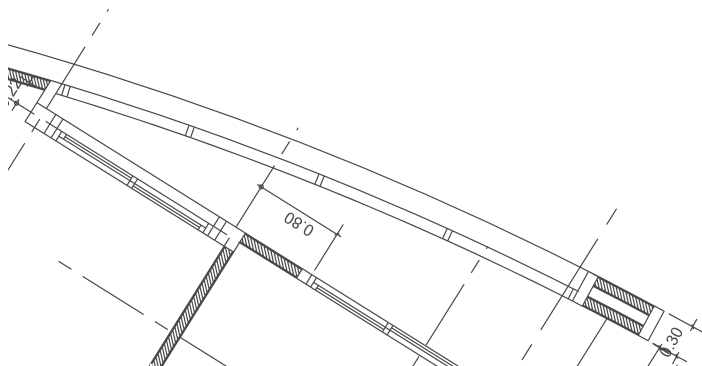

2rd Annual Winner  
WINGS TO THE FUTURE  
GRAND PRIZE JURY AWARD

Giacomo Garziano  
Italy

Reconstruction of a family house

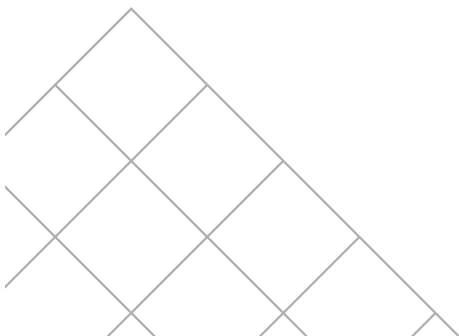
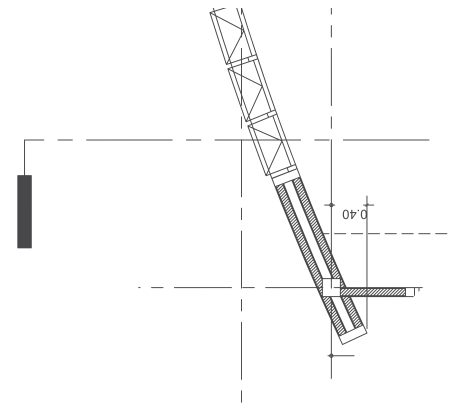

# 1rd Annual Winner WINGS TO THE FUTURE GRAND PRIZE JURY AWARD

Jakub Hoffmann  
Czech

Aula for the Finnish Museum of Architecture

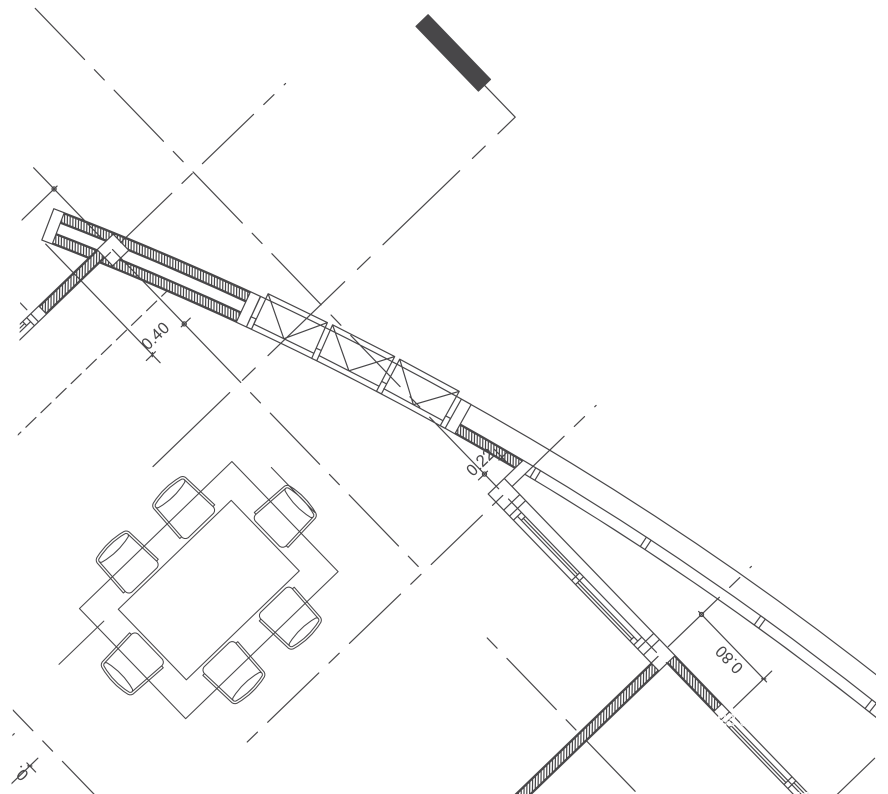

# INSPIRELI AWARDS

Main media partner:



Supported by:



Obec architektů  
Society of Czech Architects  
UIA member

## CONTACT:

---

Karel Smejkal, Ph.D., Intl. Assoc. AIA  
INSPIRELI Co-founder  
m: +420 777 234 012  
e: [smejkal@inspireli.com](mailto:smejkal@inspireli.com)  
[www.inspireliawards.com](http://www.inspireliawards.com)